

Major

OPERATORS MANUAL



Paper Folding Machine

INTRODUCTION & SPECIFICATION

The 'Major' **PAGE 4**

SAFETY Do's & Don'ts **5**

THE 'MAJOR'

Labeled Photograph **6**

QUICK START CHART (METRIC) **8**

QUICK START CHART (IMPERIAL) **9**

QUICK START GUIDE **10**

'MAJOR' OPERATOR INSTRUCTIONS

Side Lay **11**

Paper Gate **11**

Suction Opening **11**

Setting the 'Short Suck' or 'Long Suck' mode of operation **11**

Setting the Vacuum Bleed **11**

Setting the Speed **11**

Air Distribution Knob (D) **12**

Air Separation Knob (E) **12**

Back Stop (F) **12**

Fold Plates **12**

Roller Tilt **13**

Deflect **14**

Stacking Roller **14**

Emergency Stop Switch (S) **14**

Main Switch (T) **14**

Feed Switch (U) **14**

Batch Knob (V) **14**

Reset Switch (W) **14**

Overlap **14**

Speed Control (R) **14**

Plug-in Perforator **15**

Fitting Perforator Blades **16/17**

Setting Perforators **18**

Scoring **19**

Illustration of Plug-in Perforator **19**

Folding Card **20**

Paper Jams **20**

'MAJOR' OPERATOR INSTRUCTIONS (CONTINUED)

Roller Adjustment	21
Sensor Cleaning	22
Folding Plates - Maintenance	22

FOLDING TIPS & TROUBLE SHOOTING

Sheets Difficult to Feed	23
Double Sheet Feeding	23
Fold is not Square or Consistent	23
Paper will not Stack Consistently	24
Paper will not Deflect when using One Fold or Perforating	24
Total and Batch Counter not Working	24
O-Lap Keeps appearing on Counter Board	24
No Power to Machine	25
Main Switch Cuts Out	25
Fold Roller Replacement	25

DISPATCH KIT	26
---------------------	-----------

ACCESSORIES & OPTIONS	27
----------------------------------	-----------

RECOMMENDED SPARES	28
---------------------------	-----------

morgana**Major****INTRODUCTION AND SPECIFICATION**

The Major is designed to be used in today's environment of document production, the Major can be used by non skilled personnel by following this easy to use operators guide. There are very few operator adjustments required on the machine and our **QUICK START** section will get you started very quickly, but we do recommend that you take a little time to read this manual, to ensure that you fully understand the machine. We have also included a **TIPS & TROUBLE SHOOTING** section. Be sure to read this section before calling a service engineer to avoid unnecessary expense. A maximum paper weight cannot be specified, as this can be governed by the hardness of the substrate or the type of fold required to be produced.

IMPORTANT the operating environment should be controlled to a temperature between 16° C and 27° C Maximum.

Specification

Feeding System	Bottom suction feed
Max. Sheet Size	674mm Long x 365mm Wide (26.5" x 14.37")
Min. Sheet Size	160mm Long x 140mm Wide (6.3" x 5.5")
Max. Paper Weight	240gsm Max. according to hardness, type of fold, grain direction and substrate
Min. Paper Weight	56gsm
Max. No. Folds per Sheet.....	2
Max. Fold Length	337mm (13.25")
Speed per Hour (A4 Material)	27,500 sheets (Stream Feed) 17,250 sheets (Pulsed Feed)
Speed per Hour (A3 Material)	18,000 sheets (Stream Feed) 13,250 sheets (Pulsed Feed)

Note: The production speed varies according to the material size.

Dimensions	L: 1168mm H: 990mm W: 493mm
Weight	120Kgs (+11Kgs packing)
Power Requirement	1 phase 220 / 240v

Safety Do's & Don'ts

Do - read this operator manual fully before operating the machine.

Do - operate with the designated AC current only. Use an exclusive outlet, as overloading may cause fire or an electric shock.

Do - install the power cord out of the way to avoid a tripping hazard.

Do - beware of finger traps when replacing roller cassette and fold plates.

Do not - install the machine in an unstable place such that it tilts or shakes.

Do not - unplug the plug or unplug the power cord from the outlet with a wet hand, this can cause an electric shock.

Do not - unscrew and remove any covers from the machine, as it can cause an electric shock or injury.

Do not - place receptacles containing liquids on any surface.

Do not - adjust any part of the machine whilst rollers are running

Do not - operate the machine with loose or trailing clothing or loose hair.

Do not - under any circumstances adjust the paper gate when the machine is switched on.



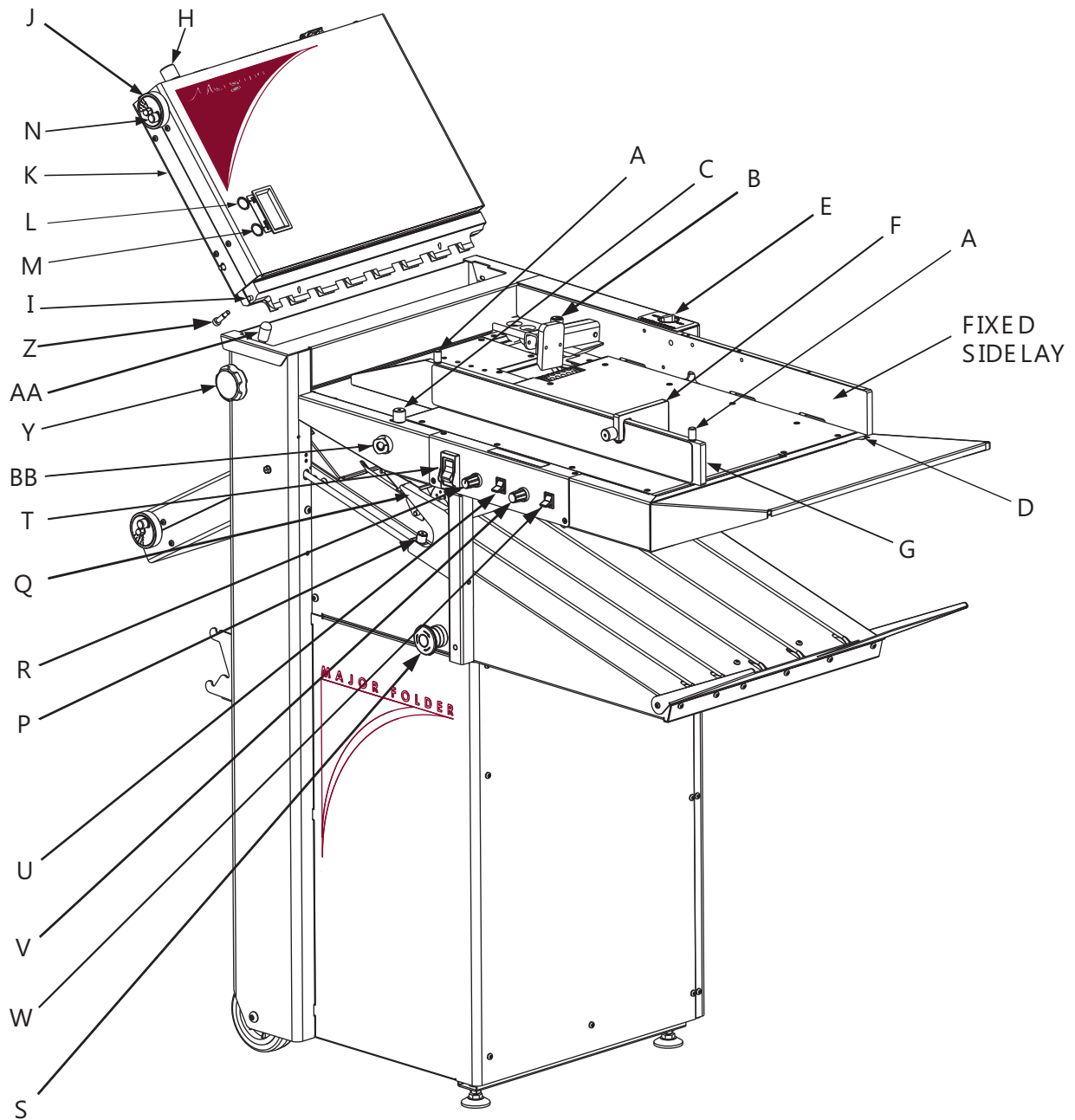



Do not - under any circumstances remove the fold plates when the machine is switched on.



morgana
Major

PAPER FOLDING MACHINE





BLANK
PAGE

<i>Morgana Major</i>		QUICK START CHART (METRIC)			
FOLD TYPE	PLATE POSN	PAPER SIZE			RESET SWITCH
		A5	A4	A3	
 LETTER	TOP	70	98	139	PULSE or STREAM
	BOTTOM	70	99	139	
 HALF	TOP	105	148	209	PULSE or STREAM
	BOTTOM	D	D	D	
 DOUBLE PARALLEL	TOP	105	148	209	PULSE or STREAM
	BOTTOM	53	74	105	
 CONCERTINA	TOP	140	198	280	PULSE ONLY
	BOTTOM	70	99	139	
 ENGINEERING	TOP	157	224	315	PULSE ONLY
	BOTTOM	52	74	105	
 GATE	TOP	53	74	105	PULSE ONLY
	BOTTOM	104	149	210	

Fold Plate Setting Figures are for Guidance Only. Final Adjustment is Likely to be Required, Dependant on Speed etc.

Morgana
Major

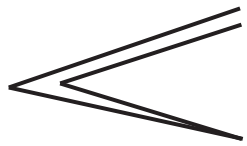
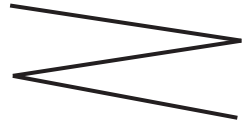
QUICK START CHART (IMPERIAL)

FOLD TYPE	PLATE POSN	PAPER SIZE				RESET SWITCH
		5½x8½	8½x11	8½x14	11x17	
 LETTER	TOP	2.795	3.615	4.630	5.625	PULSE or STREAM
	BOTTOM	2.780	3.620	4.630	5.595	
 HALF	TOP	4.240	5.475	7.035	8.510	PULSE or STREAM
	BOTTOM	D	D	D	D	
 DOUBLE PARALLEL	TOP	4.240	5.455	7.000	8.495	PULSE or STREAM
	BOTTOM	2.055	2.680	3.470	4.210	
 CONCERTINA	TOP	5.645	7.310	9.395	11.360	PULSE ONLY
	BOTTOM	2.780	3.610	4.600	5.580	
 ENGINEERING	TOP	6.355	8.255	10.575	12.795	PULSE ONLY
	BOTTOM	2.055	2.630	3.470	4.190	
 GATE	TOP	2.100	2.750	3.505	4.260	PULSE ONLY
	BOTTOM	4.205	5.475	7.000	8.495	

Fold Plate Setting Figures are for Guidance Only. Final Adjustment is Likely to be Required, Dependant on Speed etc.

QUICK START GUIDE:

1. Set the paper gate gap (knob B) to two thickness of the paper to be folded.
2. Place the paper to be folded onto the loading table against the fixed side lay.
3. Unclamp the moving side lay (knobs A) and slide up against the side of the paper but allow approximately a 1/2 mm or 1/64 inch gap between the moving side lay and the paper.
4. Clamp the backstop (F) onto the moving side lay at the back of the paper stack.
(Note) Do not attempt to load too many sheets onto the loading table during set up as this may affect the feeding operation.
5. Look at the diagram showing the various fold types and standard paper sizes. Select the type of fold that you require to make.
6. Unlock the fold plate locking knob (H) on the fold plates and press button L on the 1st fold plate. This will display the fold plate setting position. Turn the dial J to the dimension required as indicated on the fold type diagram. Lock knob H. Repeat this operation for the 2nd fold plate.
7. Fold a sheet of paper by hand to the finished folded size and set the delivery stacking roller.
8. Set the Speed Dial (R) to the required position.
9. Make sure you have power to the machine and that knob (S) is turned onto the ON position. Start the machine with switch (T) and by pressing the feed switch on and off quickly you will feed a single sheet. Check the fold for correct length and adjust if necessary. If correct, zero the counter by pressing switch W upwards. Select batch size if required by turning knob (V). Press the feed switch and the machine will start the folding operation.

OPERATOR INSTRUCTIONS

SIDE LAY

Place a single sheet of the job onto the loading table.

Release the side lay clamp screws (A) and slide the side lay just up to the sheet so that there is about half a millimetre clearance or 1/64 inch

Tighten the clamp screws.

PAPER GATE

Adjust the height of the paper gate using knob (B) (clockwise to lower, anti-clockwise to raise) so that the clearance above the vacuum roller is two thicknesses of the paper to be folded. Do not make this adjustment, when the face of the paper gate is above a hole in the vacuum roller, if it is, rotate the vacuum roller by hand to bring the metal between holes below the paper gate.

On this machine, the paper gate is fixed in an optimum position and cannot be moved backwards and forwards (horizontally).

SUCTION OPENING

The suction slot inside the suction drum, may be adjusted by releasing knob (C) and swinging the knob in the desired position. Lighter stocks including bond will run best with the knob set to the left. For heavier stocks and curled-up stock, move the knob (C) to the right until a satisfactory position is obtained.

SETTING THE 'SHORT SUCK' OR 'LONG SUCK' MODE OF OPERATION.

The machine can be set to a 'Short Suck' mode of operation, which improves the feed of A4 sheets (in landscape orientation), and also improves the feed of sheets smaller than A4. The 'Short Suck' mode of operation is particularly useful for perforating or scoring applications.

Operation

Set the 'Feed' switch (U) on the operator panel to the up position ('Off').

Set the 'Reset Pulse' switch (W) on the operator panel to the down position ('Stream').

Turn the 'Batch' knob (V) on the operator panel to select 'P1' or 'P2' in the Batch Counter Display Window.

P1 = Short Suck mode of operation. P2 = Long Suck mode of operation.

SETTING THE VACUUM BLEED (BB).

Situated on the front of the feed table, the Vacuum Bleed Knob is used to allow more control of the suction on the vacuum drum.

When light weight paper of 90gsm and lower is being fed through the machine turn the knob clockwise to reduce the possibility of marking, or damage to the leading edge of the paper.

SETTING THE SPEED. (Speed setting dial 'R')

- 0 = Slow (Use for Delicate Paper and accuracy)
- 3 = Recommended Perforating Speed
- 10 = Fast (Use for Medium Weight Paper)

Note:- Use setting number 6 for normal use.

AIR DISTRIBUTION KNOB (D)

Depending on the length of the sheet, the air distribution knob (D) should be rotated to supply the air to the correct ports as follows -

Position 1 - This is for short sheets A5 or 8" long with only port 1 open

Position 2 - This is for sheets A4 or 11" long with the front port and port 2 open

Position 3 - This is for the longest sheets A3 or 17" with the front port and port 3 open.

Position 0 - In this position, only port 2 is open and can be used on long sheets with the curl up where you need to blow air into the centre of the stack.

These setting positions are only a guide and some experimentation may obtain a better result with non-standard settings.

(Note) Position 1 feeds most paper stocks and sizes, thus the air distribution knob can be left in this position for most jobs.

AIR SEPARATION KNOB (E).

This knob controls the amount of air that is fed to the paper. The machine would normally run with this knob set at the 'High' position. If the machine is run with less than approximately 20 sheets on the loading table, or running the job to the last sheet, this knob should be set to the low position.

BACK STOP (F)

This is placed up to the end of the paper stack and clamped to the moving side lay (G).

FOLD PLATES

Fitting

Fit the fold plates into their respective positions (long fold plate upper and short plate lower), by locating the front pins (I) into the long slots and carefully sliding forwards (without twisting) until the rear pins can be located into the short slots. When fully in position, pull down the fold plate to lock into position.

Settings

Set the fold length by releasing the lock knob (H) and rotating the dial (J). The fold length may be read on a manual plate directly off the scale (K) or for the digital fold plate by pressing the 'ON' button (L). More precise movements will be registered by pressing 'micro' button M which will display increments (of one tenth of a millimetre, or for imperial machines one hundredth of an inch). To preserve battery life, the display will switch off after 30 seconds.

Fold plate Tilt

If the fold needs to be tilted, this can be achieved by releasing knob (N) and turning the dial (J), **(Do not release lock knob (H))**. Moving the dial to the + direction will increase the fold length on the operator side.

Roller Tilt

Lever (AA) should always be set in the '0' (square) position. To adjust folding out of square you can move the roller assembly in the + or - direction by releasing knobs (Y) and moving lever (AA) always re-tighten Knobs (Y).

You can move knob (AA) on it's own or in conjunction with the fold plate tilt, + on the fold plate tilt moves paper in the same direction as + on the roller tilt.

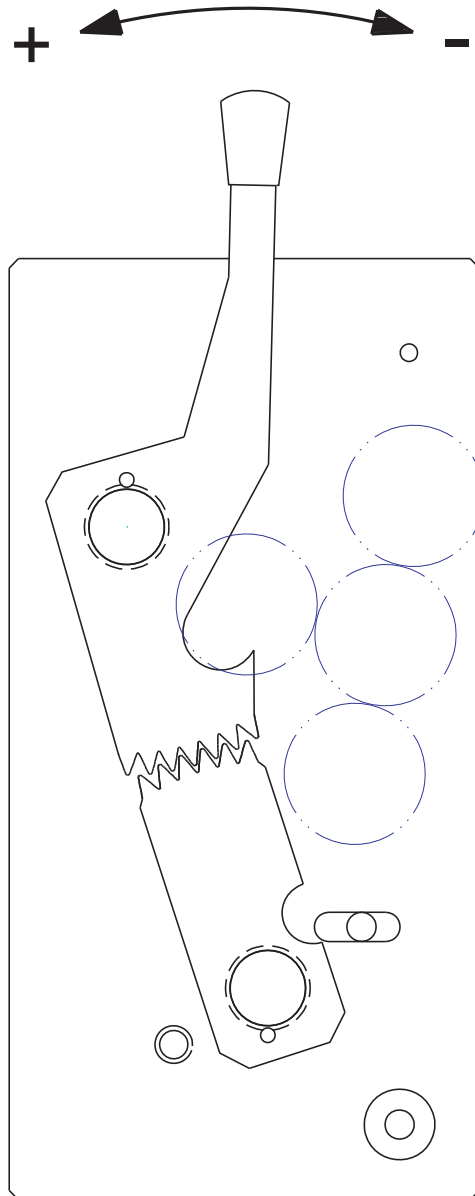

Deflect

The second (short) fold plate has the ability to be shut off into a deflect position to enable single folds to be achieved without removing the fold plate from the machine. To set the plate to deflect, first ensure that the tilt is set at zero, then after releasing the lock knob (H), keep winding the dial (J) to minimum length until it stops, then tighten the lock (H). The digital plate will show a series of dashes --- in the window.

Stacking Roller

The stacking roller must be set according to the length of the folded work. The roller is moved by releasing knob (P) while sliding the block Q to the required position. You should adjust the roller position so that when the work is stopped by the stacking roller, it lies flat on the delivery without lying on the sloping plate (R) and without the green belts showing between the sloping plate (R) and the folded sheet.

Emergency Stop Switch (S)

This switch also serves as the main isolator and when the machine is switched off at the end of the days running, press this switch to isolate the machine. To switch back on, rotate the switch head clockwise.

Main Switch (T)

The main switch (T) will run the whole machine. This switch incorporates a circuit that switches off every 100 seconds whilst the feed switch U is in the off position. The main switch may disengage seemingly at random but this is a normal function and may be instantly re-engaged.

Feed Switch (U)

Switches the feed on and off.

Batch Knob (V)

The batch knob is a rotary switch and turning the knob slightly so that it moves one position will cause the display to show the set batch quantity. Moving the knob further will change the batch quantity in multiples of 10 up to 990. Stopping the feed in the middle of a batch will not affect the batch. When the machine batches, the feed will stop and the display will show the batch quantity with a series of dashes. Feeding will resume after a short period. If batching is not required, turn the batch knob (V) until it reads 0 in the display panel. When 0 is shown after turning batch knob (V) the counter will only total count.

Reset Switch (W)

This switch has two functions:

- To set the type of feed, either pulse or stream
- To zero the total and batch counts

The switch has three positions:

- Operating the switch upwards will zero the total count and if part way through a batch, it will reset the batch count.
- After operating the switch upwards, it will spring back to its centre (default) position. In this position the feeder pauses between each sheet fed, leaving a gap between sheets. This is called pulse feed.
- Operating the switch to its lowest position will change the feed to continuous with the sheets following directly behind each other. This is called stream feed.

(Note) In the pulse position a gap of 160 mm will be set between each sheet as it is being fed into the machine. This gap prevents sheets over lapping inside the fold plates, which lessens the chance of static being generated and will decrease paper jams.

Zigzag / concertina, engineering and gate folds should only be run on pulse. By holding switch (W) down, the feed mode will switch to stream feed which will feed paper with little or no gap between the sheets. Stream feed will increase productivity but folding accuracy may be slightly impaired. Only use stream on letter, half or double parallel folds.

The pulse feed will cope with all types of fold including perforating.

Overlap

The machine has a built in system that will detect any sheet that overlaps another sheet by at least 20mm. When this happens, feeding will stop and the main switch will switch off, preventing serious jams and the display will show 'O-LAP'. Note that this is not a double detector and will not detect all double sheet feeds. However the overlap system is an indication of a tendency to double sheet feed and therefore the paper gate should be lowered slightly and the paper stack should be fanned out more thoroughly.

Speed Control (R)

The machine has variable running speeds, which are selected using the knob (R). Turn the knob clockwise to increase the speed and anti-clockwise to reduce the speed. The slow speed is recommended when running work that is difficult to stack, for example when perforating or folding an engineering type fold.

PLUG-IN PERFORATOR

The plug in perforator unit is used for perforating scoring and when folding card cover stock.

Remove the second fold plate and fit the catch tray in position by hooking it over the opening for the second fold plate. The plug in perforator unit then locates the same as the fold plate and again, take care not to twist when fitting into position. You may need to turn the hand wheel and push the perforator unit inwards to engage the drive gear.

For all applications, the unit is set on the bench using the scale to indicate positions of the blades and hubs. It is important to spread the hubs evenly across the width of the work to reduce the risk of paper jams.

When perforating or scoring without folding, the first fold plate must be removed and replaced with the second fold plate. Ensure that the tilt is at zero and set the second fold plate to deflect.

FITTING PERFORATER BLADES

The perforator blades are split into two matching halves and are fitted to the upper hubs as shown in the drawing using the four screws supplied.

A hardened anvil is fitted to the lower hub as shown in the drawing also using the four screws supplied. Again the anvils are made from matching halves. *Note - Do not mix matching halves of blades or anvils*

Important - THE PERFORATOR BLADES ARE VERY SHARP AND GREAT CARE MUST BE TAKEN WHILST HANDLING.

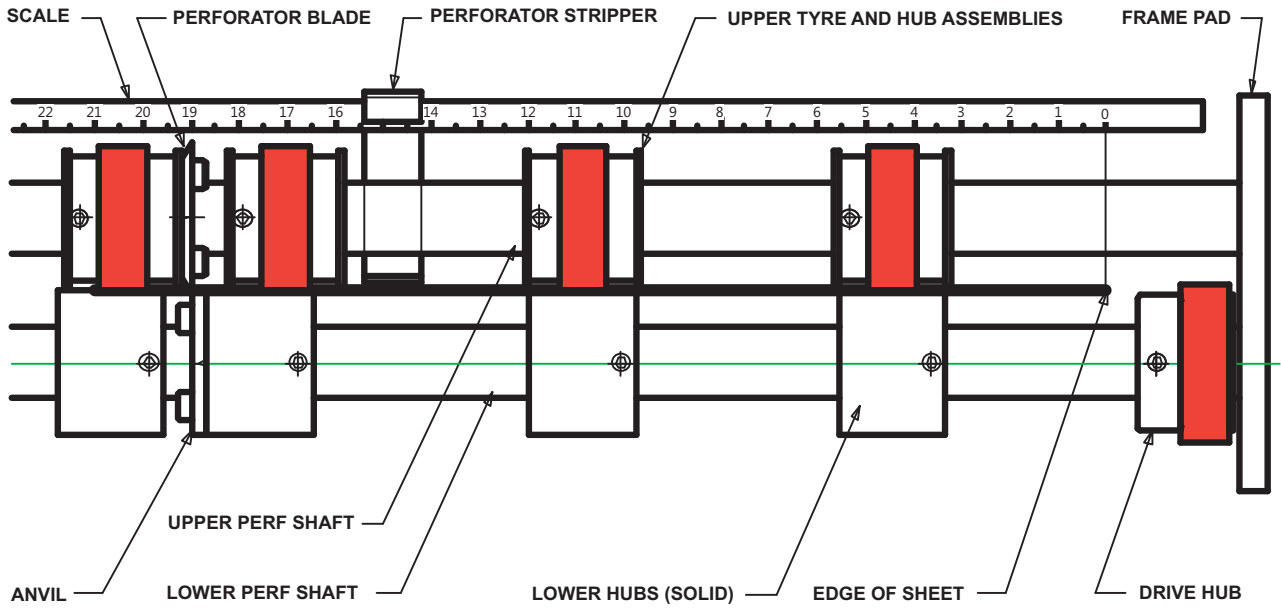

RECOMMENDED PERFORATOR SET - UP

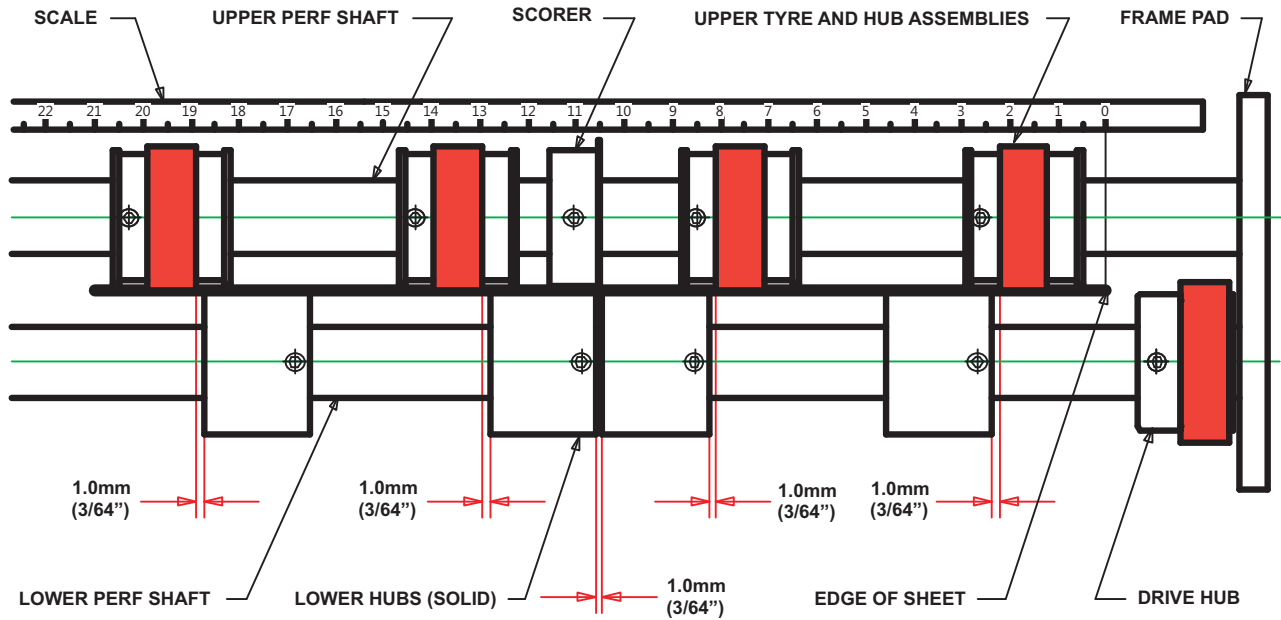

RECOMMENDED SCORER SET - UP

SETTING PERFORATORS

Upper and lower hubs can be positioned on the shaft by unscrewing the 2mm-grub screw. Slide the hub with the blade attached along, the shaft into position to correspond to the work using the scale as a guide. For example, to perforate 20mm from the edge of an A4 sheet, you would set the blade at 190mm (210 minus 20). When positioned re-tighten the 2mm-grub screw. **Important - Do Not Over Tighten This Grub Screw**

Slide the hub with the anvil, up to the perforator blade and the remaining upper and lower hubs, set as the drawing, remembering to spread them to support the sheet fully across its width.

Clip the perforator stripper adjacent to the upper hub as shown. Plug the unit into position, fit the sheet smoother into position to hold the sheets down and run the machine at the slow speed to check position.

Adjust the backstop and side guide to suit the work.
For work longer than the backstop will allow, remove the backstop and use the extended backstop that is located underneath the catch tray.

There is a full range of perforator blades available as follows:

For fine perforation	56 tooth	-	Part Number 1.99-41
For Paper	28 tooth	-	Part Number 1.99-12
For heavier Stock	20 tooth	-	Part Number 1.99-10
For use with blades	Anvil	-	Part Number 1.99-35
Slitter set for cutting		-	Part Number 1.99-13

SCORING

It is possible to score work using the plug in perforator. The scorers are split in two halves, fitted to the upper shaft and set as shown in the drawing using the scale on the unit as a guide to position. The lower hubs are moved up to but just clear of the scoring blade. The actual gap is critical and may require some experimentation to obtain a satisfactory score line. As with perforating, the remaining hubs must be spread to support the sheet fully across its width.

Scorers available:

Type A	Part Number	6.99-05	for most card
Type B	Part Number	6.99-06	for deep score
Type D	Part Number	6.99-09	for paper

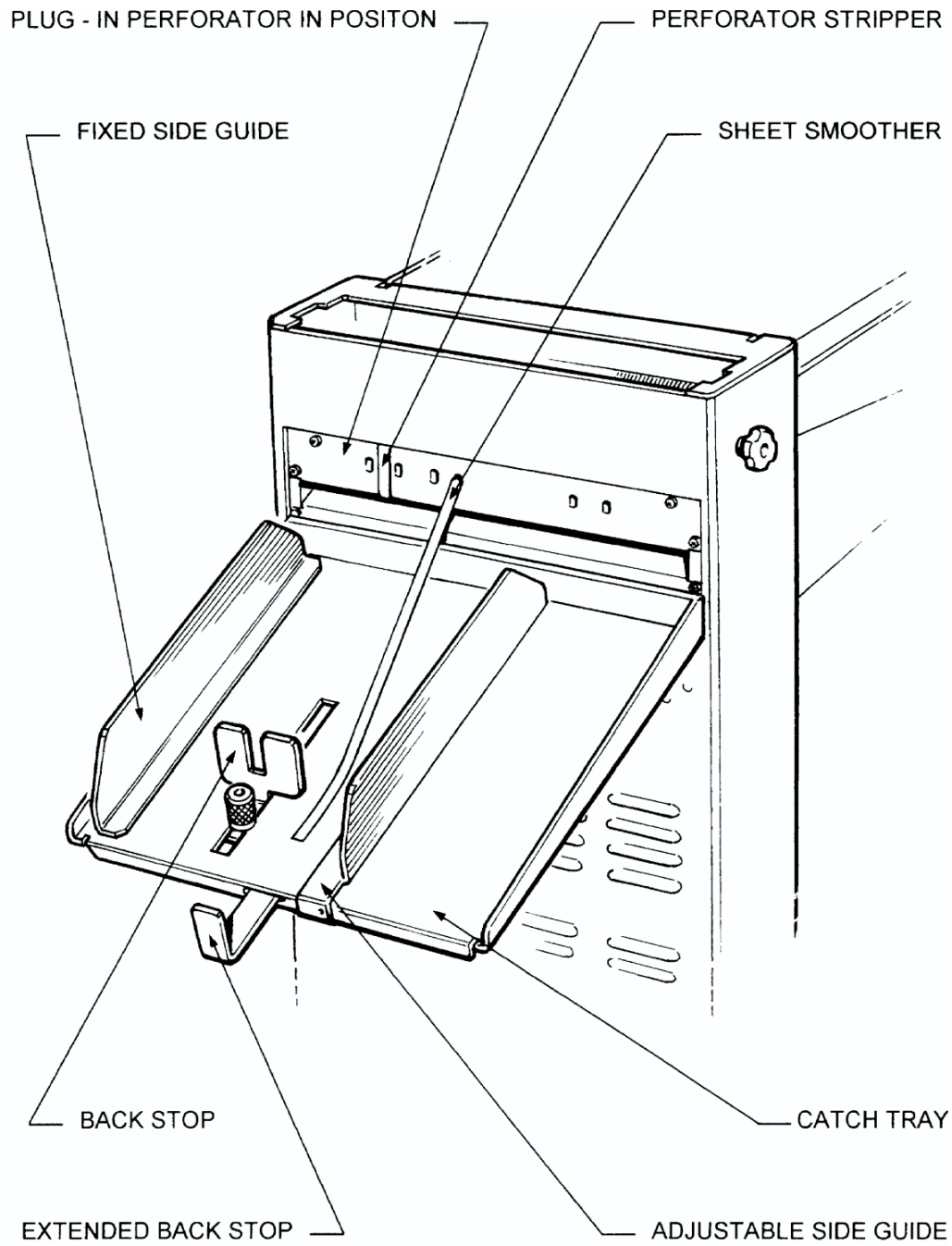

PLUG - IN PERFORATOR UNIT

FOLDING CARD

For best results, the card material should always be printed cross grain as this causes less resistance when folding. Pre scoring of card stock is also recommended

By using the plug in perforator unit to deliver card, the problem of the stock curling will be minimised. Set the backstop and side guide to suit the work. It is recommended that when folding card, the machine is set to batch after twenty sheets, which will allow easy off loading. For longer runs a optional rear delivery belt stacker (Assy. No. 9-09-01) is recommended to be used.

In the event of a paper jam, the sensor will cut out the main switch. The main fold rollers are linked to a clutch, which will prevent sheets continuing to feed.

PAPER JAMS

If for some reason a piece of paper jams in the machine, remove and check inside the fold plates. If there is paper jammed around the fold rollers take hold of a roller and wind them by hand to remove the jam. If it is impossible to wind the roller by hand, remove the roller assembly as described below. After clearing a paper jam, always check inside the fold plate (see Fold Plate Section) to make sure no torn pieces of paper are jammed inside the plate.

ROLLER ASSEMBLY - REMOVAL

The complete roller assembly unit can be removed from the machine simply by unscrewing the knobs (Y) on each side and taking hold of the rear roller and lifting out the unit. This is beneficial to clear paper jams, and to clean the roller for maintenance.

With the roller assembly removed, the safety circuit prevents the machine from running. Clean the rollers with a stiff brush between the grooves using the QD wash supplied with the machine. Replace the roller unit in the reverse sequence.

ROLLER ADJUSTMENT

The unique fold roller design of your machine will fold most paper stocks without the need for adjustment. If you have a requirement to fold very delicate or thicker stock or re-feeding to produce a cross-fold the fold roller gap can be easily adjusted as follows: -

1. Remove the roller assembly from the machine as described on page 20.
2. Loosen the Cap Head Screw on the operators side of the roller that you wish to adjust (any of the 3 outer rollers) using the 5 mm Bondus 'L' wrench provided & release the M8 lock nut on the non-operators side with the 13 A/F spanner provided.
3. Insert the 4 mm hex ball driver into the socket screw at the end of the roller shaft and rotate in the required direction to adjust the roller gap.
4. The graphics on the inside of the roller side plate show which way to turn the roller to adjust the gap relative to the centre roller.
5. Re-tighten the half nuts & cap head screws to lock the roller into position.
6. Repeat procedure for each roller that you wish to adjust and then replace the roller assembly into the machine.
7. Reset the roller tilt knob (AA) back to the zero central position and screw in the Clamping Knobs (Y).

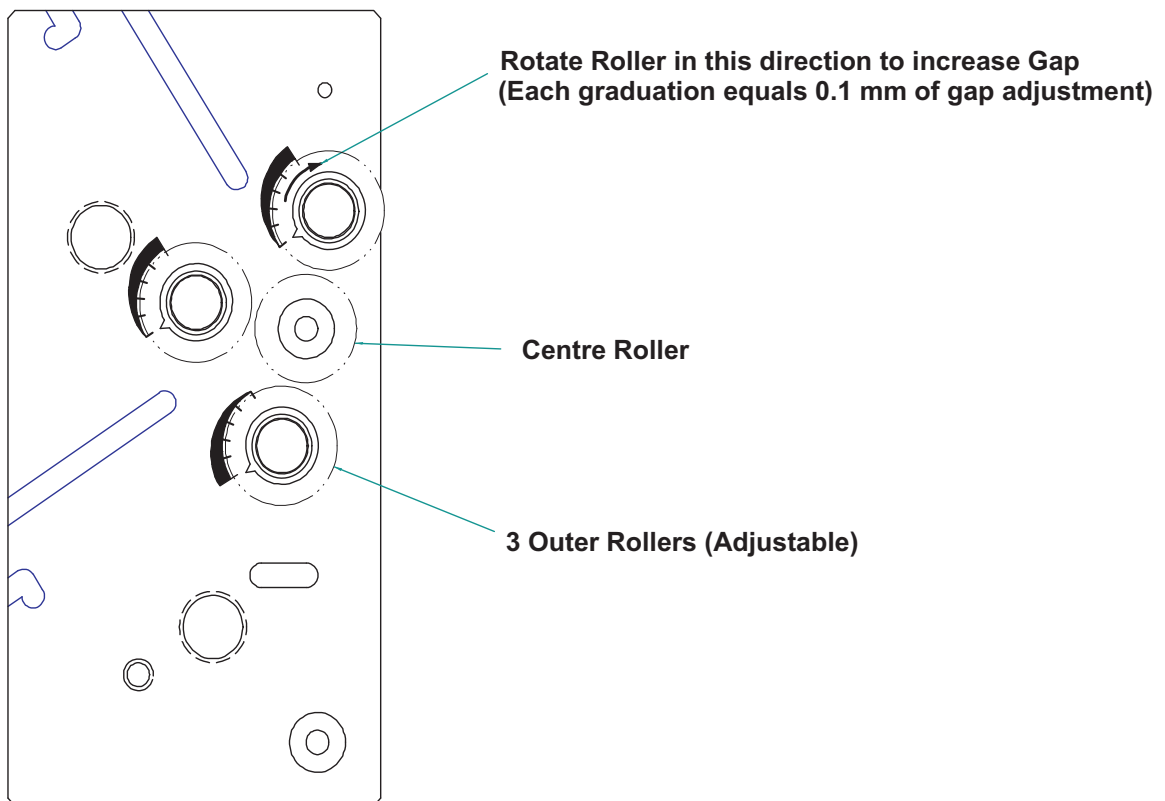

Section Through Roller Assembly

SENSOR CLEANING

The sensors, that detect and count the sheets, are located on the end of the ball holder just next to the fold roller unit. If the counter is failing, the sensors can be accessed for cleaning by removing the roller assembly as described above. Clean by using a soft brush or damp cloth.

FOLD PLATES - MAINTENANCE

The fold plates can be opened up for maintenance, cleaning, etc by removing the lock knob (H) and removing the two bolts (Z). The fold plate will then open up to enable paper jams to be removed or cleaning on digital fold plates, replacement of the battery. (Battery Part Number 613.379)

FOLDING TIPS AND TROUBLE SHOOTING:

SHEETS DIFFICULT TO FEED

Check that you have not got too many sheets in the feeder. Heavy-coated stock will not feed as high a pile as for example 80-gsm copier paper.

Make sure the moving side lay is not pushed in too tightly against the paper. Similarly, if the moving side lay is set too far away from the paper stack, this will allow the air to escape instead of blowing through the paper.

Make sure that the gap under the paper gate (B) is not set too low.

Turn the Air separation knob (E) to the high position.

Make sure that air distribution knob (D) is set correctly.

If the paper width varies you may need to trim the sheets to the same size.

If the paper is curling upwards the suction drum may not be able to pull the sheet downward to wrap around the drum for efficient feeding. You may need to bend the sheets downward prior to loading.

DOUBLE SHEET FEEDING

Make sure the gap under the paper gate (B) is not set too high.

Make sure the air distribution knob (D) and the air separation knob (E) are at the correct setting.

In extreme cases you may need to separate the sheets prior to loading.
Make sure you run on Pulse not Stream.

FOLD IS NOT SQUARE OR CONSISTANT

Check the sheets are all exactly the same size and are square before folding as you can only fold accurately if the material is consistent.

Make sure you have no foreign bodies such as fragments of torn paper inside the fold plates or the fold rollers.

Check that the fold plates are locked and located securely and that the tilt mechanism is set to zero and locked.

Check that the stock is not too heavy, particularly if folding against the grain.

Check that the moving side lay is set up to the paper, without too much gap that will allow the sheets to twist

PAPER WILL NOT STACK CONSISTENTLY:

Make sure the feed is consistent before attempting adjustments to the stacker.

Set the stacking roller position as described in the manual. Sometimes a small repositioning of the roller will improve the stacking.

If the paper is too curly when being delivered, place the catch tray and plug in perforating unit with blades disengaged into position and deliver out the back. This applies to single fold applications only. If two folds are required, you may need to reduce the weight of stock to achieve the desired results.

PAPER WILL NOT DEFLECT WHEN USING ONE FOLD OR PERFORATING:

Check to make sure that the second plate is being used as the deflector.

Make sure that the plate is located securely and that the deflector bar is wound right to the end.

Set the tilt mechanism to zero

Check that the material is not too heavy to deflect.

TOTAL AND BATCH COUNTER NOT WORKING:

Clean the sensors as described in the manual.

O-LAP KEEPS APPEARING ON COUNTER BOARD

If the overlap keeps tripping in and cutting off the machine, first check you are not feeding doubles and reset the feeder.

Overlap tripping can also mean that the machine is slowing slightly which may mean the material is too heavy.

Check that you have no foreign bodies or torn paper stuck inside the plates or machine.

NO POWER TO MACHINE

If control panel display fails to come on, check that isolator switch (S) is not pressed in. To release, turn knob clockwise.

Check power supply to the machine.

MAIN SWITCH CUTS OUT:

The feeder will cut out automatically after 100 seconds if the main switch is left on without the feed switch being activated.

The compressor inside the machine requires up to 28 amps to start running. You must have the machine plugged directly into a 30-amp ring main. Do not attempt to run the machine with an extension lead.

The main switch will cut out if you have a paper jam or overlap is indicated.

FOLD ROLLER REPLACEMENT:

Your machine has been designed to make fold roller replacement an easy and low cost operation. Your local sales agent will be able to supply you with a complete replacement roller assembly which allows you to change the roller assembly yourself as described in the roller assembly removal section of this manual. You will need to send back to your agent the existing roller assembly.

ITEM	PART NUMBER	QTY	DESCRIPTION
1			
2	90-103	1	OPERATORS MANUAL
③	90-018	1	ROLLER CLEANING KIT
④	78-007	1	BACK STOP ASSEMBLY
⑤	1 - 99 - 35	1	ANVIL SET
⑥	1 - 99 - 41	1	PERFORATING SET - 56T - SLITTING
⑦	6 - 99 - 05	1	SCORING SET - TYPE A
8	613-316	1	POWER CORD - (EEC)
	650-015	1	POWER CORD - (USA)
	613-453	1	POWER CORD - (NAGEL & FRENCH))
9	617-004	5	GLASS BALL
10	620-004	1	HEXAGON BALL DRIVER 4mm
11	620-006	1	ALLEN KEY 1mm
12	620-007	1	HEXAGON BALL DRIVER 2mm
13	620-020	1	HEXAGON BALL DRIVER 2.5mm
14	620-025	1	BONDUS 'L'WRENCH 2.5mm
15	620-027	1	BONDUS WRENCH 5mm
16	620-032	1	COMBINATION SPANNER 13mm A/F
17	624-018	1	DISPATCH BOX

ITEM	PART NUMBER	DESCRIPTION
1	6 - 99 - 05	SCORING SET - TYPE A
2	6 - 99 - 06	SCORING SET - TYPE B
3		
4	1 - 99 - 10	PERFORATING SET - 20T SLITTING
5	1 - 99 - 11	PERFORATING SET - 20T SLITTING - HEAVY DUTY
6	1 - 99 - 12	PERFORATING SET - 28T SLITTING
7	1 - 99 - 41	PERFORATING SET - 56T SLITTING
8		
9		
10		
11	1 - 99 - 13	SLITTING BLADE SET
12	1 - 99 - 35	ANVIL SET
13		
14	98 - 018	PERFORATOR STRIPPER SET
15	69 - 023 - 3	SHEET SMOOTHER - STACKER
16	6 - 99 - 36	PAPER PROFILE ROLLERS - SET (SPLIT)
17		
18		
19		
20		

ACCESSORIES....

....May be obtained from your dealer and fitted to your machine using the instructions supplied, or by reading your operators manual.

OPTIONS....

....May also be obtained and fitted by your dealer. You should not attempt to fit options as specialist tools and knowledge are required.

PART No.	DESCRIPTION
601-021	MAGNETIC ACTUATOR
606-028	FOOT - Black
606-030	SCALLOP KNOB - Black
607-022	TWIN GRIP TIMING BELT
607-025	TIMING BELT
607-026	TIMING BELT
607-027	TIMING BELT
609-011	'O' RING
609-013	'O' RING
609-014	'O' RING
609-023	'O' RING
613-059	FUSE HOLDER
613-184 or 95-138	MOTOR SPEED CONTROLLER - PCB
613-237	CAP
613-255	SOLENOID COIL
613-365	EMERGENCY STOP SWITCH
613-376	SWITCH 10 AMP - 12v COIL - (EEC)
613-383	SWITCH 16 AMP - 12v COIL - (USA)
613-385	KNOB
613-386	NUT COVER
681-005	FUSE - 3.15A - 20x5mm - FAST BLOW CERAMIC
91-068-02	MOTOR SHAFT ASSY - DC Drive - Extended
92-010	TRANSPORT BELT - Delivery
92-027-01	DRIVE BELT - Delivery - Flat 12mm
93-021	FEED BELT
93-022	DRIVE BELT - Vacuum Roller
93-028	SMOOTHER - Delivery
94-028	LOCK PIN ASSEMBLY - Side Lay
95-020	LENS - Display
95-021	CONTROL PCB - Junior
95-046	SWITCH ASSEMBLY - Reset / Pulse / Stream
95-047	SWITCH ASSEMBLY - Feed
95-049	ROTARY ENCODER ASSEMBLY
95-109	POT & LEAD ASSY. - Motor Speed

PART No.	DESCRIPTION
95-112	CHOKE ASSY. - PM63 - 3.5A
95-129-01	PLUNGER & SPRING ASSY
95-132	HOSE - Air Seperation
95-133	HOSE - Vacuum
96-028-02	FOLD ROLLER ASSEMBLY - Standard
96-049-02	FOLD ROLLER ASSEMBLY - Bottom
96-031	DRIVE BELT - Large Roller Drive
97-040	POSITIONAL DISPLAY - PCB
97-075	POT & LEAD ASSEMBLY

NOTE....

The items listed above represents parts which are subject to wear, loss, or accidental damage, and is included for your guidance only.

Replacement of parts fitted to your machine require specialist knowledge and should therefore be entrusted to your dealer.

Technician Maintenance

It is recommended that your machine is fully serviced at least once every six months by a factory trained Service Engineer.

PRODUCT RECYCLING & DISPOSAL

European Union

Disposal Information for Commercial Users



Application of this symbol on your equipment is confirmation that you must dispose of this equipment in compliance with agreed national Procedures.

In accordance with European legislation end of life electrical and electronic equipment subject to disposal must be managed within agreed procedures.

Prior to disposal please contact your local dealer or representative for end of life take back information.

Disposal Information for Domestic Users



Application of this symbol on your equipment is confirmation that you should not dispose of the equipment in the normal household waste stream.

In accordance with European legislation, end of life electrical and electronic equipment subject to disposal must be segregated from household waste.

Private households within EU Member States may return used electrical and electronic equipment to designated collection facilities free of charge. Please contact your local disposal authority for information.

In some Member States when you purchase new equipment your local retailer may be required to take back your old equipment free of charge. Please ask your retailer for information.

Other Countries

Please contact your local waste authorities and request disposal information.